



SEFI



amri

SISTO KB DN20 PI

Code informatique SEFI : 9202174

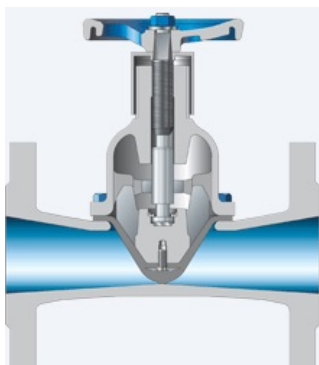

Désignation

ROBINET A MEMBRANE SISTO FONTE PN10/EPDM SERIE COURTE

Caractéristiques

Matière du corps :	FONTE
DN :	20
Matière Membrane :	EPDM



Informations données à titre indicatives, non contractuelles