

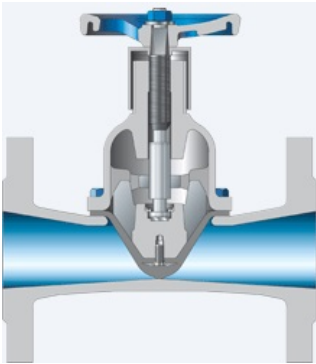

SISTO KB DN15 PI

Code informatique SEFI : 9202173



Désignation ROBINET A MEMBRANE SISTO FONTE PN10/EPDM SERIE COURTEg

Caractéristiques

Matière du corps :	<u>FONTE</u>
DN :	<u>15</u>
Matière Membrane :	<u>EPDM</u>

header found or type unknown

Informations données à titre indicatives, non contractuelles