

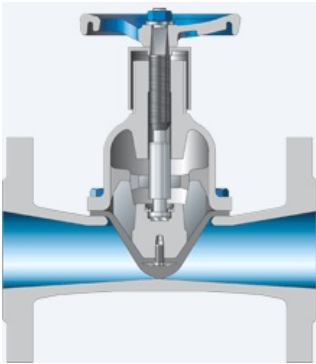

## SISTO KB DN100 PI

Code informatique SEFI : 9202181



**Désignation** ROBINET A MEMBRANE SISTO FONTE PN10/EPDM SERIE COURTEg

**Caractéristiques**

Matière du corps :	<u>FONTE</u>
DN :	<u>100</u>
Matière Membrane :	<u>EPDM</u>

header found or type unknown

Informations données à titre indicatives, non contractuelles